

Installation Problems

Problem	Cause	Solution
The keypad lever turns after entering a correct code but does not retract the latch.	The spindle is too short or has been cut down too short.	Please call the Borg Locks helpline on 0800 44 88 377 for a replacement.
The keypad lever handle slips when withdrawing the latch.	The spindle may not be going into the back of the keypad straight and is restricting its movement.	Ensure that the spindle is going into the back of the keypad straight. If the problem persists please call the helpline.
The levers are stiff to turn from either side of the door.	Ensure that no material is affecting the rotation of the spindle followers and that the spindle is not catching on the cut-out in the door.	If there is no material restricting the rotation, it may be a case that the lock fitted in the door is heavily sprung. To reduce handle pressure the inside handle return spring can be removed.

After Installation Problems

Problem	Cause	Solution
The keypad lever turns freely without having to enter any code.	The unit has been incorrectly coded or is in free passage mode.	Please refer to 'how to change your code number' instructions (page no.7 & 8) or 'operating the free passage function' (page no.4).
The latch bolt is not securing when the door is closed.	The strike plate / keeps may not be adjusted correctly or the door may have swollen or twisted if in direct sunlight.	Adjust the strike plate / keeps in accordance with the manufacturer's recommendations.
The inside handle or keypad lever does not return to the horizontal position after turning.	The grub screw has been done up too tightly or the handle return spring has broken.	Loosen the grub screw by 1/4 of a turn until it springs back. If after loosening the grub screw the problem persists, it may be that the handle return spring has snapped. Please call the Borg Locks helpline for assistance.
After entering a correct code the handle is solid and not turning.	The multi-point lock has been double locked.	Unlock the cylinder and the handle of the keypad should now turn and unlock the door.

Maintenance: No maintenance of the internal parts should be necessary. If the lock is being used on an exterior application it is advisable to periodically remove the keypad and give the coding chamber a light spray with a PTFE based lubricating spray.

Do not use oil as a lubricant as it will cause excessive wear to the internal parts.

Guarantee: If your lock should develop a fault within 1 year from date of purchase, due to inferior materials or workmanship the goods will be repaired or replaced free of charge.

Please call our helpline for spares, repairs and technical advice - **UK: 0800 44 88 377**
- **International: +44 (0) 1708 225700**

Disclaimer: Under no circumstances should the lock be dismantled as this will invalidate our warranty.

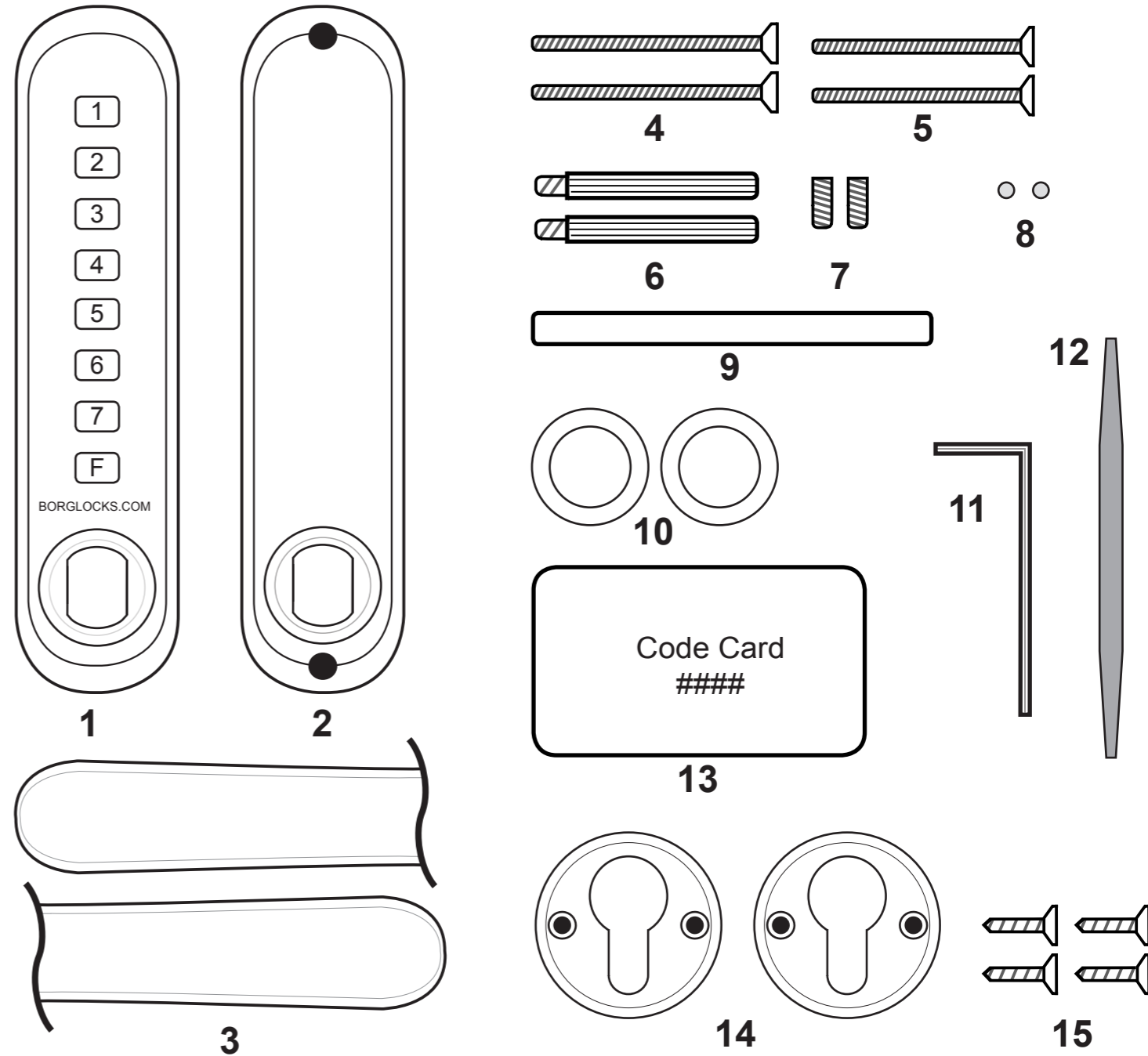

Contents

- | | | |
|--------------------------|--------------------------|-----------------------|
| 1. Keypad | 6. Hexagon Support Posts | 11. Allen Key |
| 2. Inside Handle | 7. Grub Screws | 12. Code Change Tool |
| 3. Lever Handles | 8. Grommets | 13. Code Card |
| 4. Machine Screws (60mm) | 9. Spindle | 14. Escutcheons |
| 5. Machine Screws (40mm) | 10. Handle Washers | 15. Escutcheon Screws |



Preparation

Please check that all parts are working correctly. Once the lever handles have been fitted to the keypad and inside handle, enter the factory preset code as printed on the code card (part no.13), rotate the lever handle on the keypad downwards, re-enter the code and turn the handle upwards ensuring that the spindle follower on the back of the keypad rotates each time - an audible click should be heard every time a correct code is entered and the lever handle is turned. Both lever handles on the keypad and inside handle should return easily under their own spring pressure. Please refer to 'fitting the lever handles' below.

If you intend to change the code please refer to 'how to change your code number' instructions (page no.7 & 8) prior to fitting.

Determining the Hand of the Door

Many of the installation instructions refer to the handing of the door. The hand of the door is determined with the door in its closed position from the exterior or keypad side of the door, as shown in the diagram on the right.

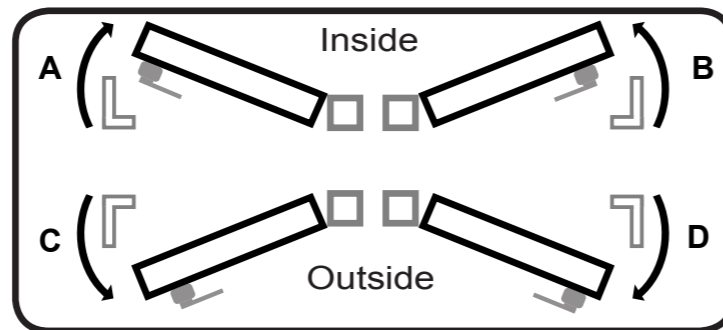

A) Right hand door – door opens inward (push), hinged on the right side.

B) Left hand door – door opens inward (push), hinged on the left side.

C) Right hand inward opening – door opens outward (pull), hinged on the right side.

D) Left hand inward opening – door opens outward (pull), hinged on the left side.

Fitting the Lever Handles

The unit is non-handed and the lever handles (part no.3) are not supplied fitted. Once you have determined what handing of door you have, the lever handles can be fitted to the keypad and inside handle. This is done as follows:

Ensure that one of the handle washers (part no.10) is placed around the handle holder before the handle is secured in place with one of the grub screws (part no.7) and tightened using the allen key (part no.11).

With the lever handles secured to the keypad and inside handle turn the lever handle upwards and downwards to ensure that they return under their own spring pressure to the horizontal position. If both lever handles return under their own spring pressure cover the grub screw holes with the grommets (part no.8).

If the handle does not return under its own spring pressure loosen the grub screw by 1/4 of a turn until it springs back.

How To Change Your Code Number

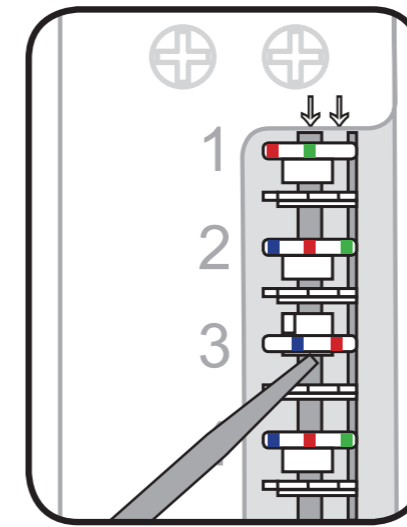

Set as single press
Red Marker

Fig.6

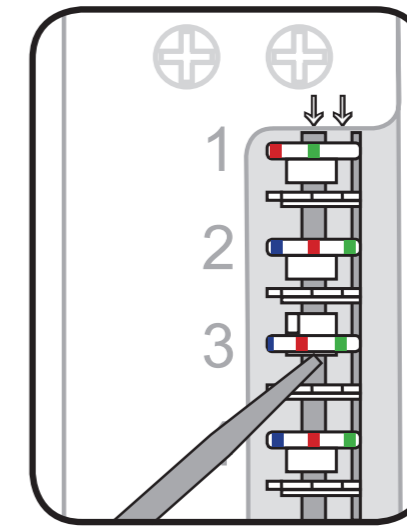

Set as double press
Green Marker

Fig.7

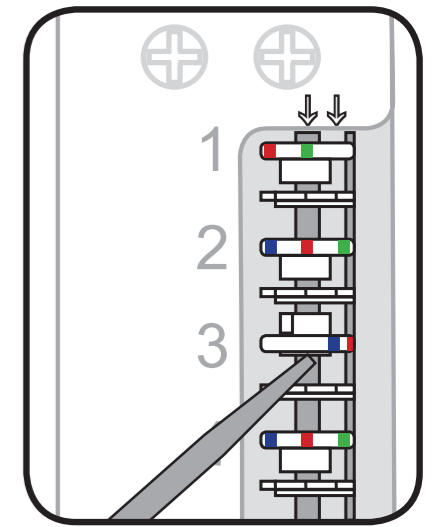

Not in the code
Blue Marker

Fig.8

6. With the selected marker in position the inner gear can be released. The tab of the inner gear will still be visible (as per fig.9) – using your finger rotate the coding disk around to the left / clockwise until you see the tab of the inner gear drop down into the cut-out of the coding disk (as per fig.10). Once the tab has dropped down rotate the handle and you should see that the marker you have set is in alignment with the left hand arrow.

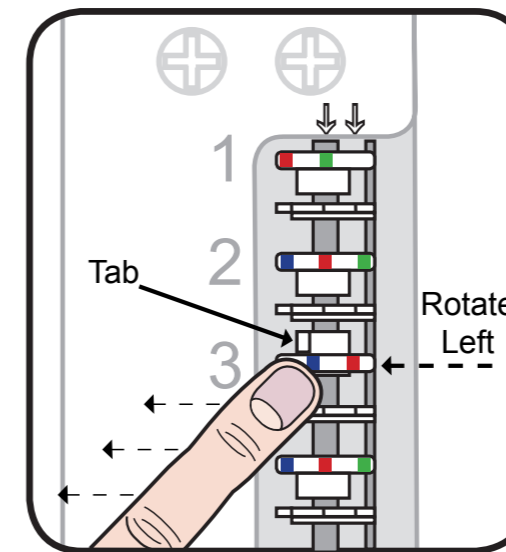

Fig.9

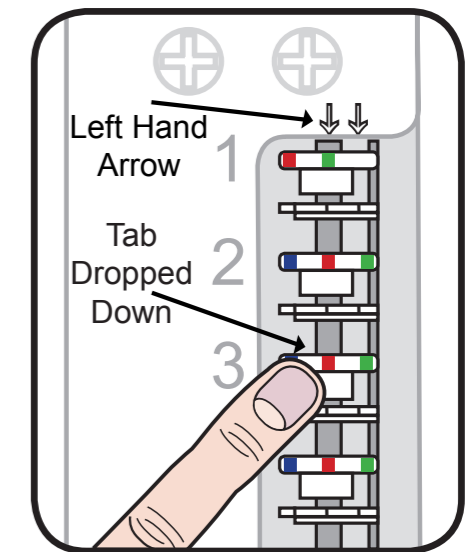

Fig.10

7. Once the first digit has been set, the principle is the same for any other button that you want to set in the code. Once you have programmed all the required digits in your code, turn the handle to reset the coding chamber and ensure that all the buttons that are in the code have the coloured markers in alignment with the left hand arrow on the keypad cover plate. Make sure that any digit that is not in the code has the blue marker of the coding disk in alignment with the left hand arrow.

Hints & Tips

If you look on the top edge of each coding disk you will see that there are 3 cutouts. Furthest to the right cutout (green) – for a two button press, centre cutout (Red) - for a single button press and furthest to the left cutout (blue) - for a button not in the code. The tab of the inner gear needs to sit in one these cutouts.

How To Change Your Code Number

Preparation

Please note: The keypad has a double button press function and therefore you are able to have the same digit twice. When the unit is being coded, if the green marker of the coding disk is in alignment with the left hand arrow on the cover plate it denotes that the button is set as a double press. If the red marker of the coding disk is in alignment with the left hand arrow it is set for a single press and if blue marker of the coding disk is in alignment with the left hand arrow it is not part of the code.

The coding chamber is non-sequential so the code can be entered in any order. If for instance the unit was coded to 1124 (as per fig.4 below), the unit can be opened by entering 1142, 4211, 1214 etc...

1. Remove the keypad from the door, this is done by removing the machine screws located at the top and bottom of the inside handle.

2. With the keypad and inside handle removed from the door, turn the keypad over so that the coding chamber is visible. Turn the lever handle of the keypad to ensure that the coding chamber is reset before a new code is to be programmed.

3. With the coding chamber reset you will see that the coding disks are set to what the keypad is currently coded to. If for instance the unit is coded to 1124; the number 1 disk will have the green marker of the coding disk lined up with the left hand arrow on the cover plate. The number 2 and 4 will have the red marker of the coding disks lined up with the left hand arrow (as per fig.4). All the other coding disks will have the blue line in alignment with the left hand arrow.

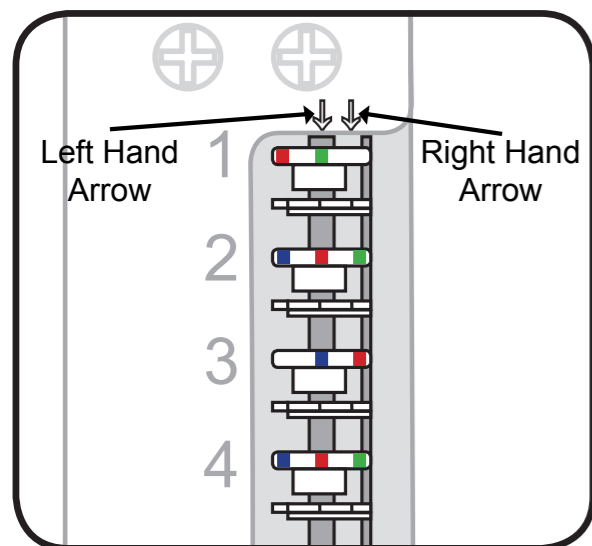

Fig.4

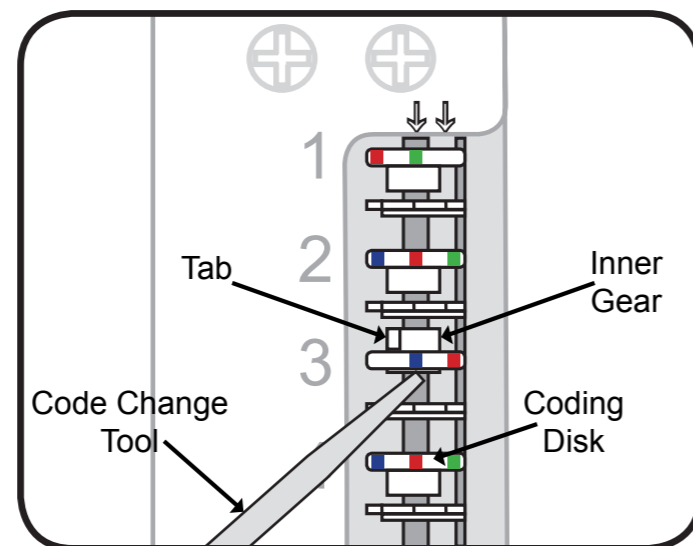

Fig.5

4. Decide what the unit wants to be code to. To change how a button is set in the code – this is done by using a small amount of upwards force lifting the inner gear using the code change tool (part no.12) until the tab on the inner gear becomes visible (as per fig.5).

5. Whilst holding the inner gear the coding disk can be rotated using your finger. If you want that button in the code as a single press align the red marker of the coding disk with the right hand arrow (as per fig.6). If you want that button as a double press align the green marker of the coding disk with the right hand arrow (as per fig.7) and if you do not want that button in the code align the blue line of the coding disk with the right hand arrow (as per fig.8).

Fitting the Hexagonal Support Posts

Fit both of the hexagonal support posts (part no.6) into the top and bottom threaded holes of the keypad, as shown in arrows A and B in the diagram on the right.

Without the hexagonal support posts fitted the machine screws will not be able to be screwed into place, as they are different thread sizes.

Do not over tighten the hexagonal support posts as this may strip the thread on either the post itself or the thread in the back of the keypad.

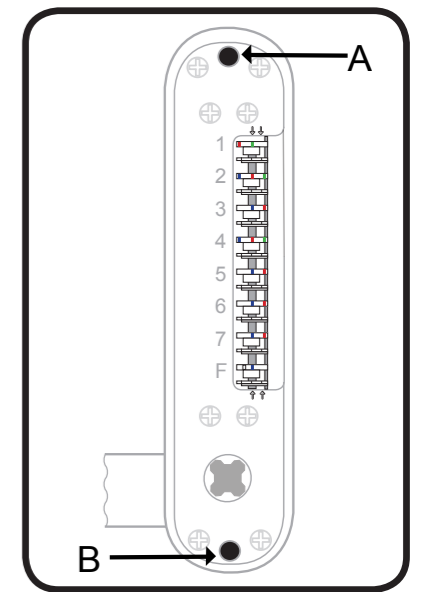

Turning off the Free Passage Function

All units are supplied with the free passage function ready to be used, unless you have specifically ordered with the function turned off. If you do not require the free passage function this feature can be turned off, this should be done before the unit is fitted to the door.

If your unit has the free passage function turned on, the white line of the 'F' coding disk will be in alignment with the left hand arrow (as per fig.1). If it is turned off the blue line of 'F' coding disk will be in alignment with the left hand arrow.

1. To turn off the free passage function – this is done by using a small amount of upwards force lifting the inner gear using the code change tool (part no.12) until the tab on the inner gear becomes visible (as per fig.2).

2. Whilst holding the inner gear the coding disk can be rotated using your finger. Rotate the disk until the blue line of the coding disk is in alignment with the right hand arrow (as per fig.3).

3. With the blue line in position the inner gear can be released. The tab of the inner gear will still be visible (as per fig.3) – using your finger rotate the coding disk around to the left / clockwise until you see the tab of the inner gear drop down into the cut-out of the coding disk.

4. Once the tab has dropped down rotate the handle and you should see that the blue marker is in alignment with the left hand arrow. If the blue line is in alignment the unit has the free passage function turned off.

If at a later date you wish to turn back on the free passage function, follow the above 4 steps but instead of setting the blue line of the coding disk set the white line.

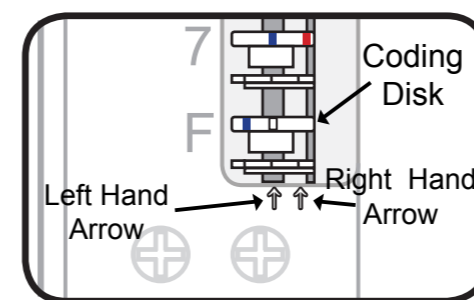

Fig.1

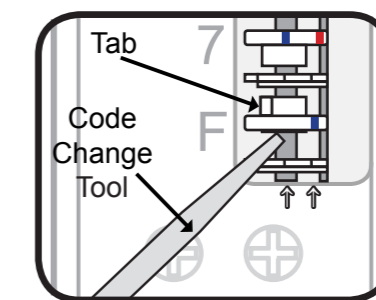

Fig.2

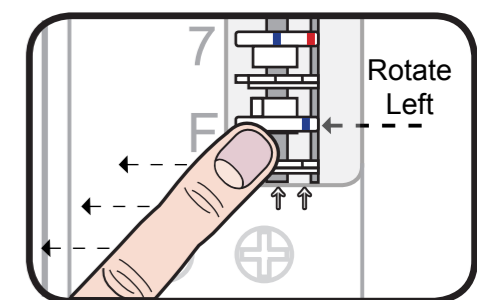

Fig.3

Preparation & Installation

Operating the Free Passage Function

When the keypad is set in the free passage function the handle will be free turning until the function is deactivated. This function is designed for high traffic / low security situations and allows users to pass through the door by turning the handle without having to enter the code each time.

The 'F' button activates the free passage function, if you want to set this function the steps are as follows:

1. Enter the code into the keypad along with the 'F' button and turn the handle.
2. The user will now be able to rotate the handle freely without having to enter the code.
3. To cancel the free passage function, press the 'F' button and rotate the keypad handle once and the keypad will return to being in the locked state.

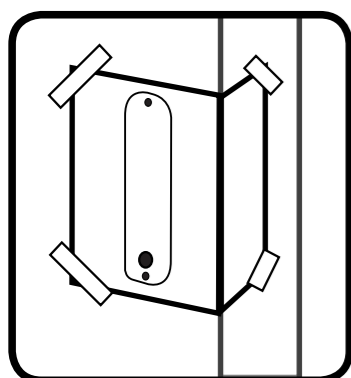

Apply the Drilling Template

If the unit is to be fitted onto a UPVC door then the door section is likely to have already been drilled out to accept a standard set of lever handles. In this case please align our drilling template from the spindle centre with the spindle centre in the door.

1. Apply the supplied template to the outside of the door so that the centre line of the keypad matches the backset of the latch taking into account that most UPVC doors have a rebated edge.
2. Mark the centres points for the top and bottom fixing holes and the hole for the spindle and drill to the correct size holes as specified on the drilling template.

Fitting & Positioning the Spindle

If the spindle needs to be cut to length, offer the keypad up to the door and put the spindle into the back of the keypad.

The ideal length of spindle protruding to go into the back of the inside handle wants to be between 10-15mm.

There is a spring located in the spindle follower of the inside handle to avoid any movement of the spindle when fitted to the door.

If the spindle is cut too short there is a chance the spindle could slip out of position and result in the user being locked out.

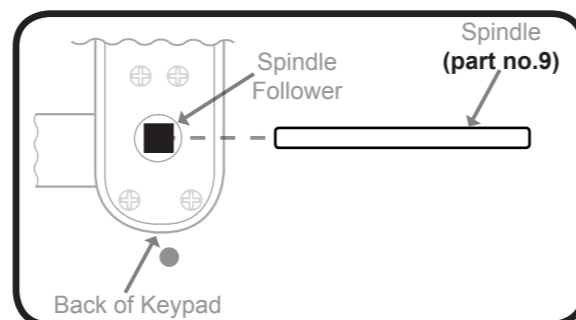

Installation & Operation

Fitting Illustration

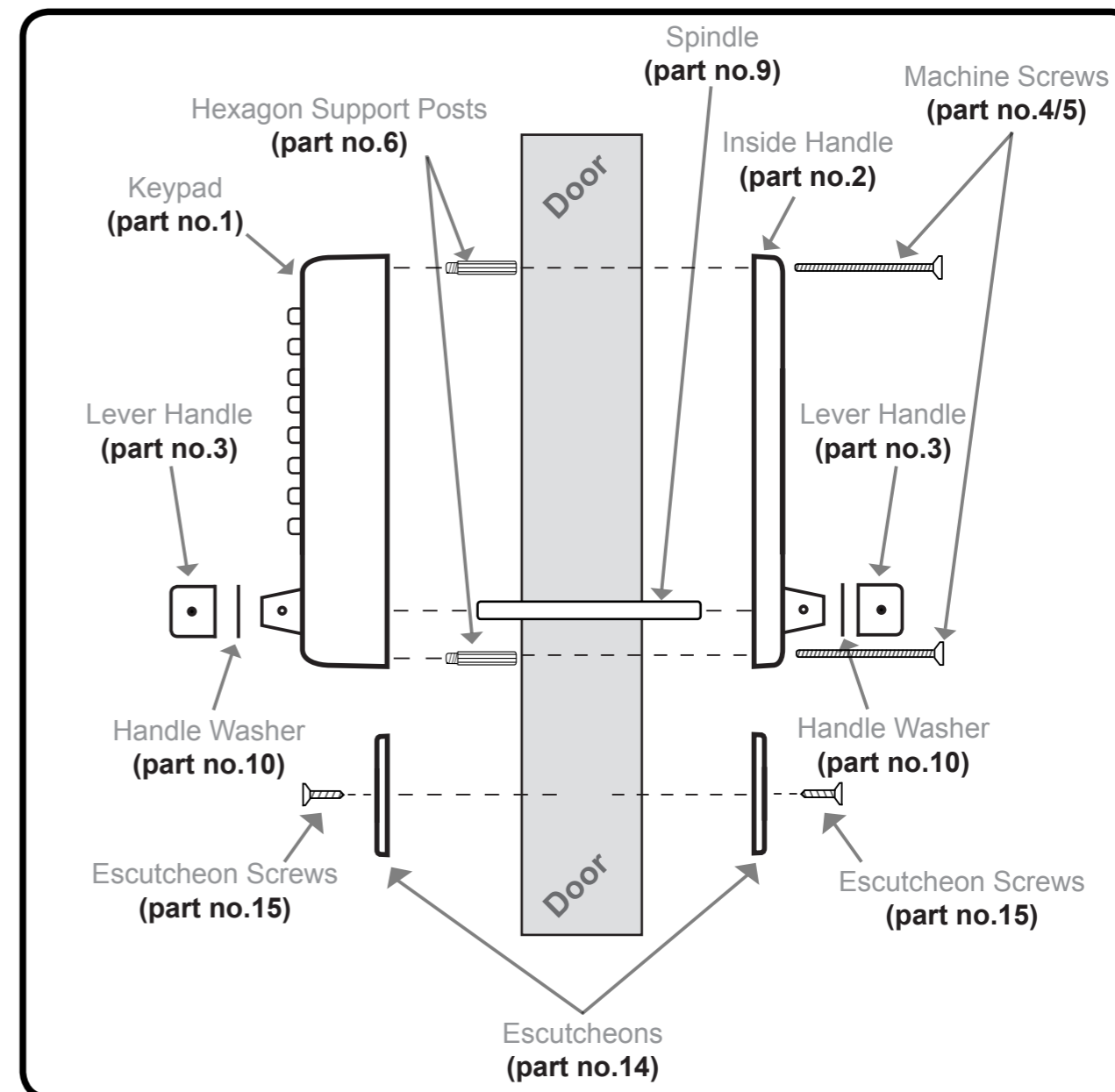

Operating the Unit

The 6000 series model has been designed to work with a variety of multi-point locks and how they work varies between different manufacturers. In the majority of cases, if the door is double locked via a key, the keypad or inside handle will not operate until it has been unlocked.

Before entering a code turn the handle to ensure the coding chamber is clear of any buttons that may have been pressed. Enter the code and turn the handle, the latchbolt and any other secondary bolts will disengage and the door will open. After the handle is turned the unit will reset and the code will need to be entered again in order to access. If there is going to be constant traffic through the door you may want to put the unit in free passage mode, please refer to 'operating the free passage function' on page 4.

If fitted to a multi-point lock and the door needs to be double locked, enter the code and lift the handle upwards this will throw any secondary bolts and the key can be turned to double lock.